

Model 302

Six Channel USB PeakSimple Data System

The **Model 302** may be used with any brand or model of GC or HPLC offering an analog detector output signal ranging from -5V to +5V. It includes three independent, programmable controls (0V to +5V analog output) for temperature & pressure or HPLC gradient formation. The Model 302 has six channels, which can be randomly assigned to one of four time bases, which allows independent start and stop times for four separate instruments. Four remote start inputs compatible with 2-wire switch closures (typically output by GCs and HPLCs as a remote start signal) are also included for your use. Two pulse stretchers are provided to accommodate instruments with remote start signals shorter than one second (such as Hewlett Packard GCs).

The computer to which you connect the Model 302 must support USB (it must have at least one USB port—rev 2.0 or higher—and use Windows™ 98, 98SE, ME, 2000, XP or newer).

With your purchase of the Model 302, you should receive the following items:

- 1 - Model 302 Data System box (front and rear views shown below)
- 2 - USB cable for connection to your computer's USB port
- 3 - Manual (either the PeakSimple Chromatography Data Systems or the SRI general product manual)
- 4 - PeakSimple for Windows™ software (inside the manual cover)



The Model 302 comes in a sturdy aluminum box consisting of top and bottom halves, secured together with two brass thumbscrews for easy interior access.



The brass thumbscrews are on the left- and right-hand panels of the Model 302 box.

Front View



POWER Indicator LED

Rear View

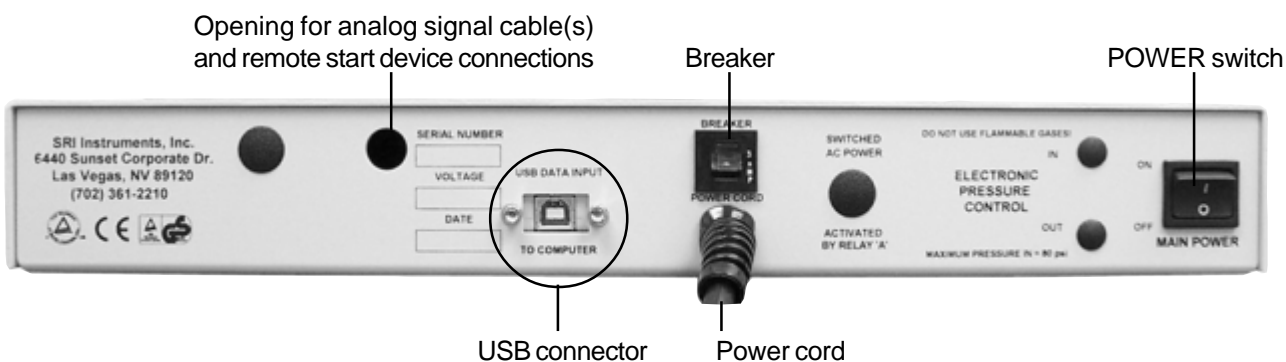

Opening for analog signal cable(s) and remote start device connections

Breaker

POWER switch

USB connector

Power cord

Model 302

Six Channel USB PeakSimple Data System

1. Open the Model 302

Verify that the Model 302 is powered OFF and unplugged. Remove the thumbscrews on both sides of the Model 302 box and slide the top cover up and off. It is connected to the bottom of the box by a ground wire, so just set it next to the bottom half of the box.

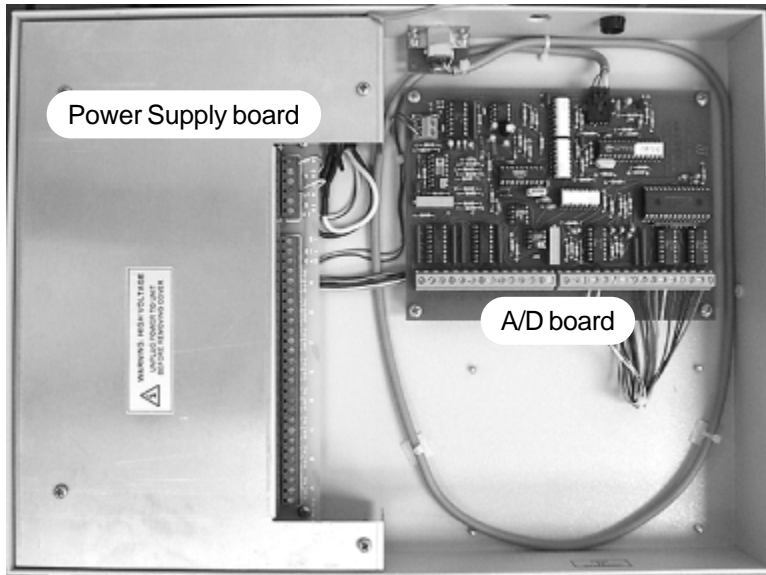

High voltage aluminum safety cover

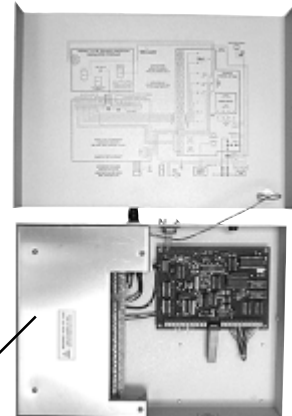

The Model 302 box contains two circuit boards. The board on the right-hand side is the A/D board. The board on the left-hand side under the removable high voltage aluminum safety cover is the Power Supply board. **If you need to remove the high voltage aluminum safety cover, ALWAYS unplug the Model 302 from the wall power outlet first** (you do not need to remove it for the wiring connections described here).

2. Connect the Analog Signal Cable(s)

NOTE: The analog output from some GCs and LCs can have a range of up to 10 volts DC. The Model 302 can tolerate this voltage input, but signals above 6 volts will generate unwanted noise and signals above 5 volts will be “clipped” (the tops of the waveforms will be cut off). Use the 1 volt output typically available on the back of your instrument.

2-1. Route the analog signal cables from your instrument through the open hole in the back of the Model 302.

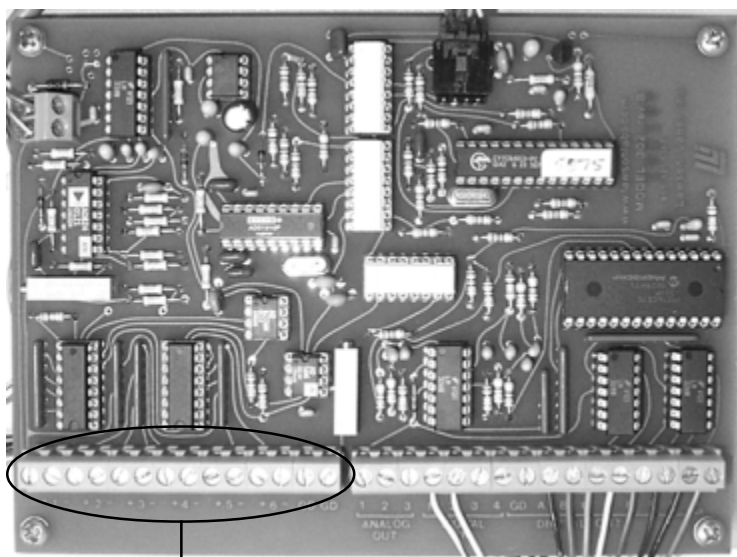

Channels 1-6 and GD (ground) screw terminals

2-2. Strip 1/4” of insulation from the “signal+” and “signal-” wires of your instrument’s signal cables.

2-3. Remove any jumpers placed in the Channels 1-6 screw terminals at the factory. Insert the “signal+” wire into the A/D board screw terminal marked “1 +” and secure the connection with a small flat-blade screwdriver.

2-4. Insert the “signal-” wire into the A/D board screw terminal marked “1 -” and secure the connection.

2-5. Repeat the connection of signal cables for channels 2, 3, 4, 5, and 6. Any unused channels **MUST** have both inputs jumpered to ground.

Model 302

Six Channel USB PeakSimple Data System

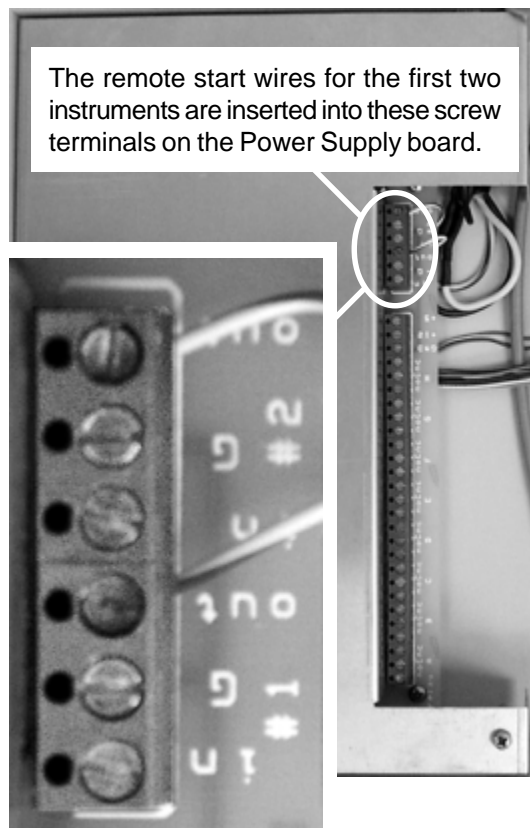

3. Connect the Remote Start Cables (OPTIONAL)

The Model 302 remote start capability allows you to start the data system by means of a switch closure. Four separate remote start circuits permit the user to individually start TIMEBASE 1, 2, 3, and 4 of the data system. In some applications, the chromatograph being used with the Model 302 may offer a remote start signal output or switch closure output that permits starting an integrator or other device when the START button is pressed on the chromatograph's on-board control panel. Typically, this signal can be used to start the Model 302. TIMEBASES 1 and 2 are equipped with pulse stretchers.

3-1. Route the remote start cable from your instrument through the open hole in the back of the Model 302.

3-2. Strip 1/4" of insulation from the "+" and "-" wires of your remote start cable(s).

3-3. Insert the "+" wire into the Power Supply board screw terminal marked "#1 IN" and secure the connection.

3-4. Insert the "-" wire into the Power Supply board screw terminal marked "#1 G" and secure the connection.

3-5. For a second instrument, insert the "+" wire into the "#2 IN" terminal, and the "-" wire into the "#2 G" terminal.

3-6. The screw terminals for the third and fourth instruments' remote starts are on the A/D board. The bank of screw terminals is labeled "DIGITAL IN" under "1 2 3 4." Connect the "+" wires for the third and fourth instruments to screw terminals 3 and 4, respectively. Connect both "-" wires to the "GD" screw terminal next to the "4" screw terminal (on the right-hand side).

NOTE: TIMEBASES 3 and 4 require a remote start signal that persists longer for than one second. Check your instruments' specifications (for example, Hewlett Packard GCs produce a very short remote start pulse, so you should connect one of these to TIMEBASE 1 or 2, which are equipped with pulse stretchers).

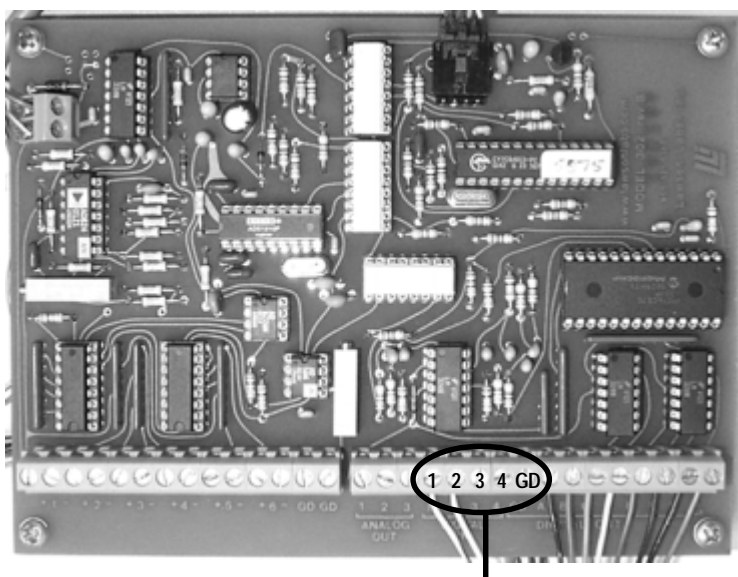

Connect the remote start "+" cables to screw terminals "3" & "4," and the "-" cables to "GD".

Model 302

Six Channel USB PeakSimple Data System

4. Connect the External Event Relay Wires (OPTIONAL)

The Model 302 has eight 0-5 volt TTL level outputs that are wired to a bank of mechanical relays with screw terminals for easy connection to any device which may be operated from a contact closure (normally open [NO] and normally closed [NC] contact closures). These relays may be turned ON and OFF individually and automatically through a PeakSimple timed event table. Manual control is also available via the computer keyboard.

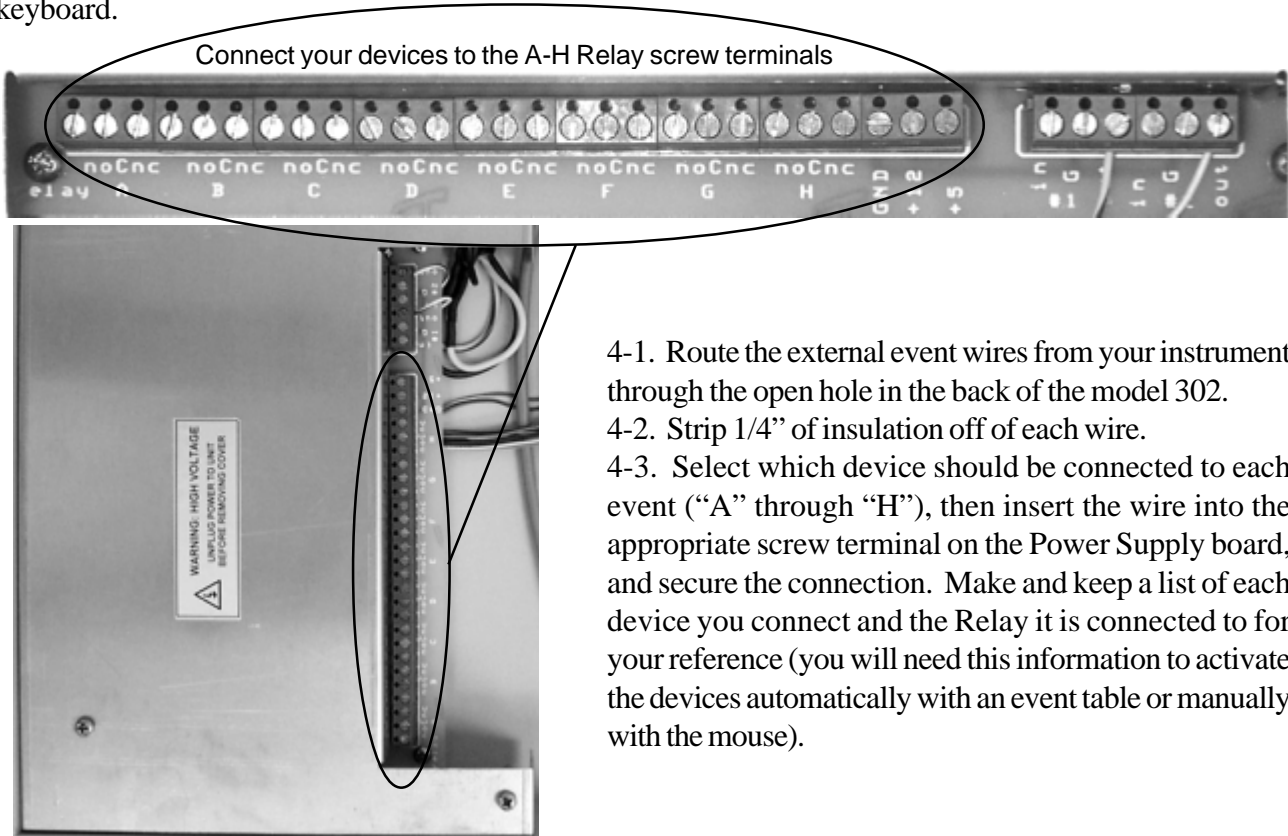

- 4-1. Route the external event wires from your instrument through the open hole in the back of the model 302.
- 4-2. Strip 1/4" of insulation off of each wire.
- 4-3. Select which device should be connected to each event ("A" through "H"), then insert the wire into the appropriate screw terminal on the Power Supply board, and secure the connection. Make and keep a list of each device you connect and the Relay it is connected to for your reference (you will need this information to activate the devices automatically with an event table or manually with the mouse).

5. Replace the cover on the Model 302 and secure it with the thumbscrews.

6. Connect the USB Cable to Your Computer

The Model 302 is equipped with a USB connector. A USB cable (provided) connects the Model 302 to your Windows™ computer's USB port. This plug and play interface permits the Model 302 to be loaded onto and operated from a desktop or laptop computer that supports USB (rev. 2.0 or higher).

- 6-1. Secure one end of the USB cable to an available USB port on your PC.
- 6-2. Secure the other end to the USB connector on the back of the Model 302.

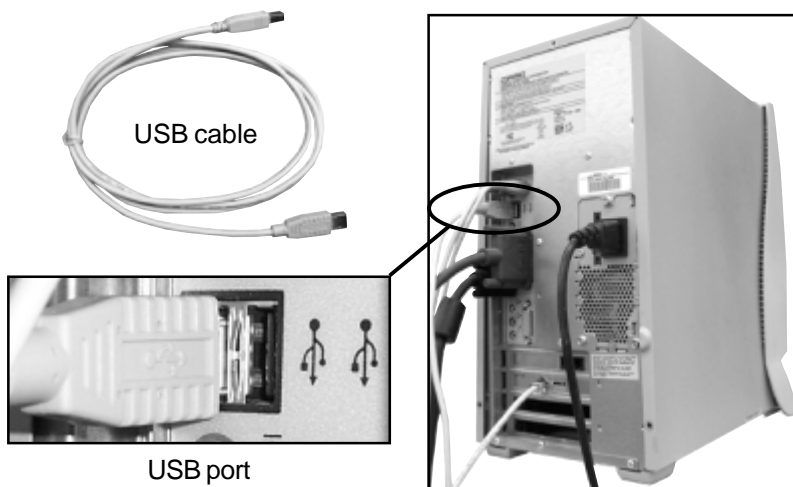

Model 302

Six Channel USB PeakSimple Data System

7. Connect Power to the Model 302

The Model 302 is provided with a power cord which plugs into a standard 110 (or 220) volt outlet. Plug the Model 302 into the wall outlet. Turn ON the power switch and verify that the POWER LED on the front of the Model 302 is lit.



The power LED is lit when the Model 302 is connected to a power source & switched ON.

8. Install PeakSimple Chromatography Software

8-1. Locate your copy of PeakSimple, which is shipped inside the front cover of your manual. Insert the CD or floppy disk(s) into your computer's appropriate drive.



8-2. Open the appropriate drive through My Computer, then double click on "Setup.exe" and follow the instructions. By default, the setup program places the PeakSimple application directory on the hard drive: c:\peak2000. If you put the application directory elsewhere, take note of the path as you may have to enter it in a dialog box during the USB driver installation procedure.

9. Install the USB Drivers

There are three important files saved to the PeakSimple application directory at the conclusion of the software installation: LL_USB.inf, LL_USB.sys, and LL_USB2K.sys. These files are required for Windows to recognize the A/D board connected to the computer's USB port.

9-1. Double-click on the My Computer icon on your desktop, then on Control Panel, then on Add New Hardware, which should open the Add New Hardware Wizard.

9-2. Click the Next button twice, until you get to the screen that gives you a choice between letting Windows find the new hardware, or selecting it yourself from a list. Click the radio button to choose the hardware from a list and click the Next button.



Model 302

Six Channel USB PeakSimple Data System



9-3. Scroll down the hardware list, click on Universal Serial Bus controllers, then click Next. From the following screen click the Have Disk button.



9-4. Click Browse and navigate to the PeakSimple application directory, or type in the path (“c:\peak2000” or the name you have chosen). The Wizard should find the LL_USB.inf file. When you click OK, the Wizard will verify that you want to copy files from the PeakSimple directory (“Copy manufacturer’s files from: c:\peak2000”).

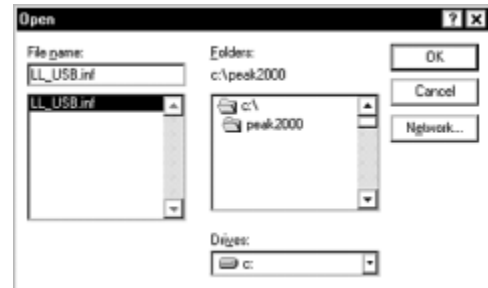

9-5. When you click OK again, the Wizard will confirm that the drivers are for Lawson Labs. Click Next on this screen and the following screen, and Windows will finish installing the software for the Model 302. Click Finish.



9-6. Restart your computer (you MUST restart your computer before the drivers will work). Open the Control Panel again, then System, then click on the Device Manager tab. If the USB drivers have been successfully installed, the Universal Serial Bus controllers section will list “Lawson Labs, Inc. USB Data Acquisition HdwVer-04.”

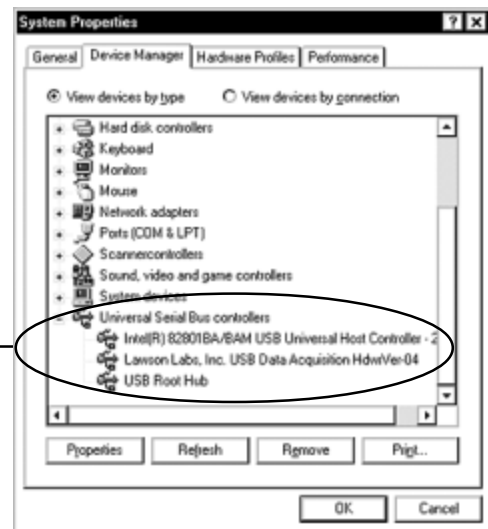
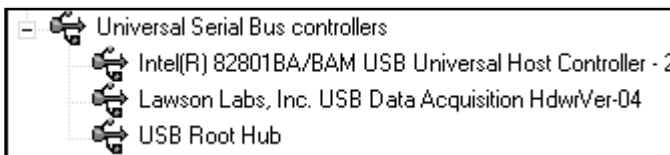



Model 302

Six Channel USB PeakSimple Data System

10. Launch PeakSimple

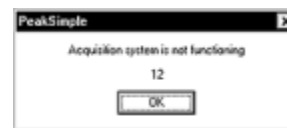
10-1. Double-click on the PeakSimple icon to launch the program. Verify that communication has been established between your computer and the Model 302. An error message will appear if communication is not established. This is normal until you complete the following step.



10-2. Each SRI USB data system has a unique 4-digit USB device number beginning with “5” (5031, 5032, etc.). This I.D. number is printed on the back of your Model 302, and on your PeakSimple disk. Open the PeakSimple Edit menu and choose Overall. Enter your Model 302 I.D. number in the box labeled “Com port / USB device number.” Click OK, and PeakSimple will attempt to “wake-up” the data system. Click the Save All  icon so you don’t have to re-enter the USB device number.

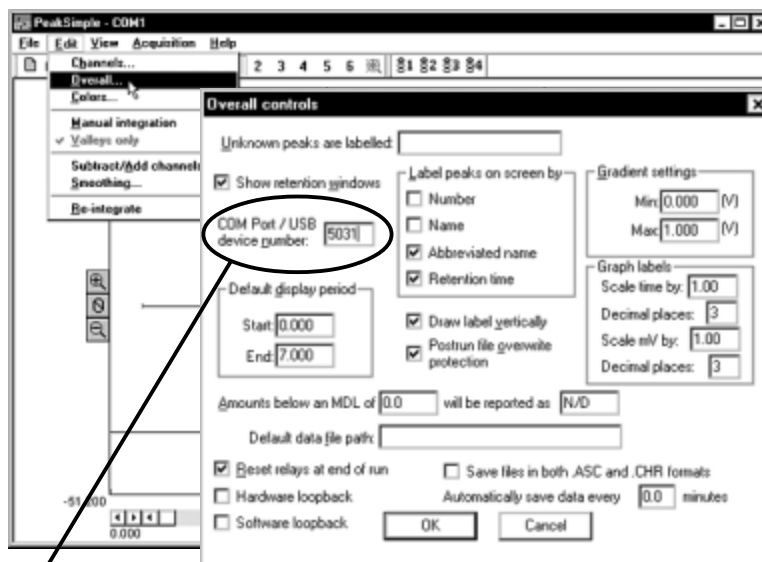

Enter the 4-digit USB device number here

10-3. For the remote start option: Open the Edit menu and choose Channels. Click on the Details button for channel 1. Verify that Remote start is enabled (the box should be checked). Repeat this step for channels 2-6 if necessary.

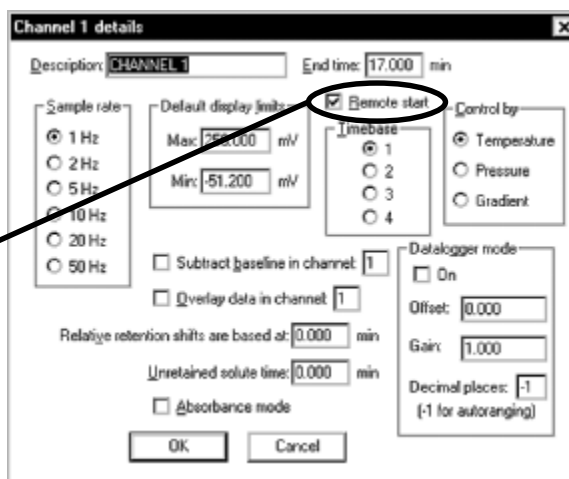

10-4. For information about using Event tables, manual Relay activation, etc., see the “PeakSimple Tutorials” and the “PeakSimple Software” sections in the manual (and online at www.srigc.com—click on the “Download Our Documents” button on the homepage).

Model 302

Six Channel USB PeakSimple Data System

11. Starting an Analysis

10-1. The upper right corner of the PeakSimple chromatogram window contains real-time information pertinent to your analysis in progress. The status of the run (STAND BY, RUN) is displayed in capital letters next to the millivolt (mV) reading, underneath the amount of time into the run.

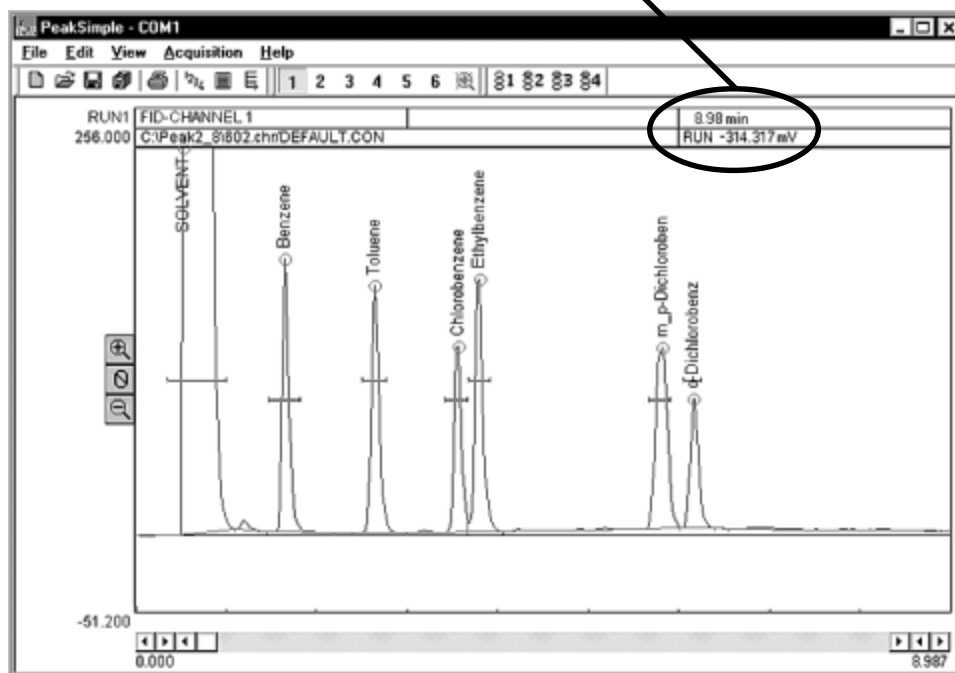

11-2. Hit your computer keyboard spacebar to begin the run, and the data is plotted onscreen in the chromatogram window.



Press the spacebar to begin the run

Press the End key to stop the run

11-3. Hit the End key on your computer keyboard to stop the run.

Technical Support:

If you have questions or problems, call SRI for free technical support at 310-214-5092, 8am - 5pm California time.